

**Mod. AB-1**  
100 a 150/5 5VA Cl. 0,5/1  
160 a 200/5 5Va Cl. 1  
**PRECIO 110,50**

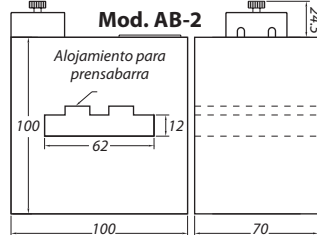

**Mod. AB-2**  
250 a 400/5 5VA Cl. 0,5/1  
500 a 600/5 10Va Cl. 1  
**PRECIO 136,50**

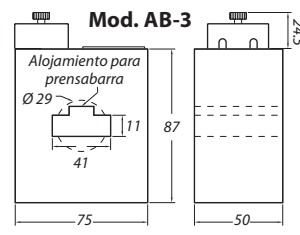

**Mod. AB-3**  
400 a 630/5 5VA Cl. 0,5  
**PRECIO 143,75**

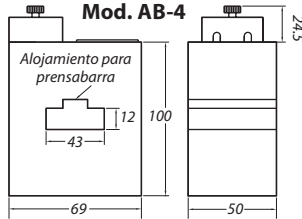

**Mod. AB-4**  
630/5 5VA Cl. 0,5  
**PRECIO 150,00**

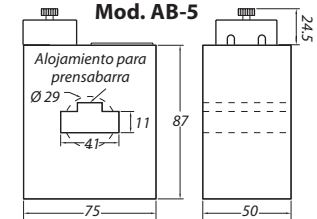

**Mod. AB-5**  
400 a 630/5 5VA Cl. 0,5  
**PRECIO 168,75**

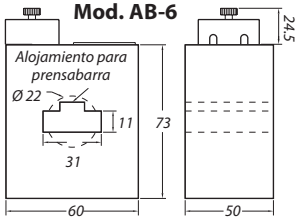

**Mod. AB-6**  
250/5 5VA Cl. 0,5  
**PRECIO 187,50**

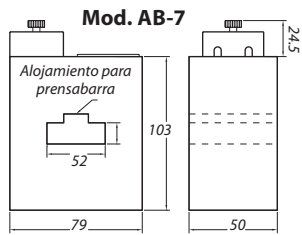

**Mod. AB-7**  
630 a 1250/5 5VA Cl. 0,5  
**PRECIO 198,75**

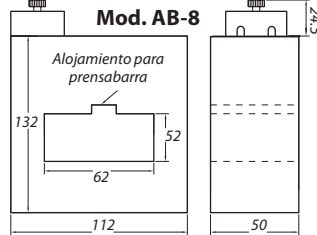

**Mod. AB-8**  
1200 a 2000/5 5VA Cl. 1  
**PRECIO 206,25**

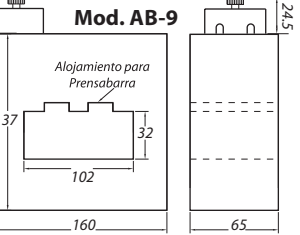

**Mod. AB-9**  
2000/5 5VA Cl. 1  
2000/5 10VA Cl. 0,5/1  
**PRECIO 218,75**

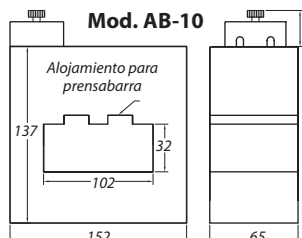

**Mod. AB-10**  
2500 a 3000/5 5/10VA Cl. 1  
**PRECIO 225,00**

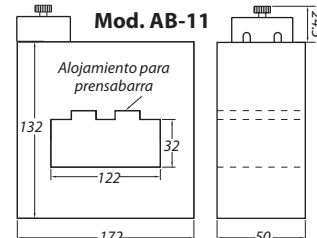

**Mod. AB-11**  
2500 a 3000/5 5/10VA Cl. 1  
**PRECIO 237,50**

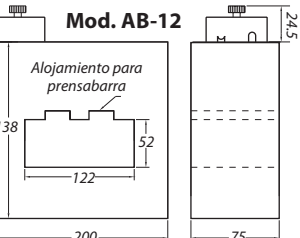

**Mod. AB-12**  
2500 a 3000/5 5/10VA Cl. 1  
**PRECIO 250,00**

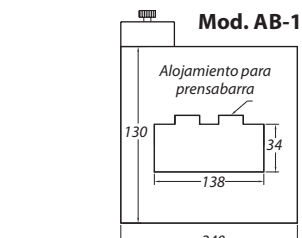

**Mod. AB-13**  
2500 a 3000/5 5/10VA Cl. 1  
**PRECIO 256,25**

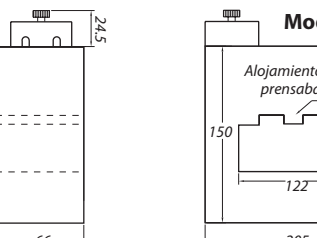

**Mod. AB-14**  
2500 a 3000/5 5/10VA Cl. 0,5/1  
**PRECIO 275,00**

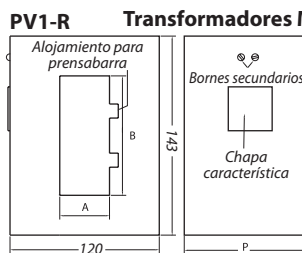

**PV1-R**  
Con ventana opcional de 25 x 50 (con prensabarra)

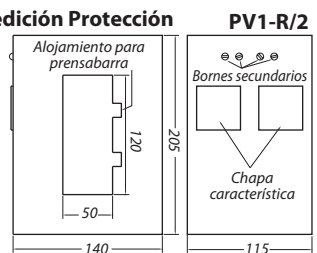

**PV1-R/2**  
Con ventana opcional de 80 x 30 (con prensabarra)



**PV1-R**  
Medición protección

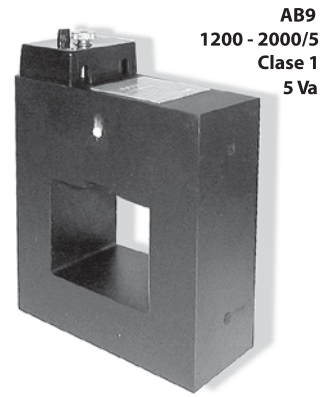

**AB9**  
1200 - 2000/5  
Clase 1  
5 Va

Especificaciones	
Tensión de servicio	0,6 kV
Tensión máx. de servicio	1 kV
N	menor a 5
Material	Resina poliéster
Color	Negro

Corresponden a todos los transformadores



**Modelo AB-8**

Relación	Mod.	VA	Clase 0,5 / 1
100 - 150/5	AB1	5	- / x
160 - 200/5	AB1	5	- / x
250 - 400/5	AB2	5	x / x
500 - 600/5	AB2	10	- / x
400 a 630/5	AB3	5	- / x
500 a 800/5	AB4	5	- / x
400 a 630/5	AB5	5	x / x
250 a 400/5	AB6	5	- / x
630 - 1250/5	AB7	5	x / x
500 a 800/5	AB8	5	- / x
1200 - 2000/5	AB9	5	- / x
2000/5	AB10	5	- / x
2000/5	AB10	10	x / x
2500 - 3000/5	AB11	5-10	x / x
2500 - 3000/5	AB12	5-10	x / x
2500 - 3000/5	AB13	5-10	x / x
2500 - 3000/5	AB14	5-10	x / x

Se fabrican transformadores bajo pedido.